

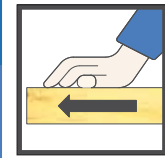





Art. 02 02



-  **FRESA PER INCASTRI SOTTILI REGISTRABILE**
-  **GROOVING CUTTERS, ADJUSTABLE**
-  **PORTE-OUTILS A RAINIER EXTENSIBLE**
-  **NUTMESSERKÖPFE, VERSTELLBAR**
-  **FRESA PARA RANURAS ESTRECHAS DE ESPESOR VARIABLE**
-  **РЕГУЛИРУЕМЫЕ ПАЗОВЫЕ ФРЕЗЫ**

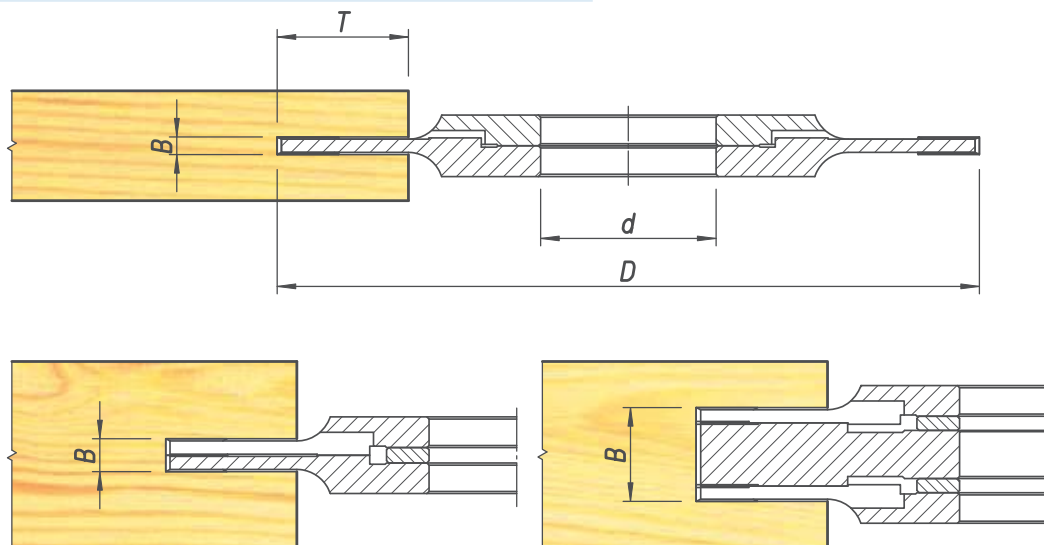

Ricambi-Spare Parts

Cod.	D	B	T	d	Z	V	RPM max
160 047 50	160	4÷7,5	25	30→50	8	4	7100
160 041 50	160	4÷15	25	30→50	10	4	7100
160 043 00	160	4÷30	25	30→50	12	4	7100
160 050 90	160	5÷9,5	25	30→50	8	4	7100
160 051 95	160	5÷19,5	25	30→50	10	4	7100
160 053 95	160	5÷39,5	25	30→50	12	4	7100
180 047 50	180	4÷7,5	35	30→50	8	4	6600
180 041 50	180	4÷15	35	30→50	10	4	6600
180 043 00	180	4÷30	35	30→50	12	4	6600
180 050 90	180	5÷9,5	35	30→50	8	4	6600
180 051 95	180	5÷19,5	35	30→50	10	4	6600
180 053 95	180	5÷39,5	35	30→50	12	4	6600

Ref.	Descrizione-Description	Dimensione-Dimension	Codice-Code
Vers. 4÷7,5	Coltello-Knive	18x18x1,95	I26.016
	Vite-Screw	Torx M4x3,5	V14.4/3.5CT
	Rondella-Ring	11,8X2,2 M4	V34.4/2.2
	Incisore-Spurs	14x14x1,2	I15.10
	Vite-Screw	Torx M4x3,5	V14.4/3.5CT
	Rondella-Ring	9,8x1,7 M4	V34.4/1.7
Vers. 5÷9,5	Coltello-Knive	18x18x2,5	I26.017
	Vite-Screw	Torx M4x3,5	V14.4/3.5CT
	Rondella-Ring	11 ,8x2,6 M4	V34.4/2.6
	Incisore-Spurs	14x14x1,2	I15.10
	Vite-Screw	Torx M4x3,5	V14.4/3.5CT
	Rondella-Ring	9,8x1,7 M4	V34.4/1.7
El. Aggiuntivo-Additional El. 7,5mm	Coltello-Knive	7,5x12x1,5	I10.01
	Vite-Screw	M5x22,5	V13.5/22.5CE
	Tassello-Wedge	6,8mm	I10.01/T
El. Aggiuntivo-Additional El. 10 mm	Coltello-Knive	9,65x12x1,5	I10.02A
	Vite-Screw	M6x24	V13.6/24CEM
	Tassello-Wedge	8,7	I10.02A/T
El. Aggiuntivo-Additional El. 15mm	Coltello-Knive	15x12x1,5	I10.03
	Vite-Screw	M6x20	V13.6/20CE
	Tassello-Wedge	14,8mm	I10.03/T
El. Aggiuntivo-Additional El. 20 mm	Coltello-Knive	20x12x1,5	I10.04
	Vite-Screw	M6x20	V13.6/20CE
	Tassello-Wedge	16,8	I10.04/T

